

A Comparative of business process modelling techniques

by Jimmy Waworuntu

Submission date: 29-Jul-2020 05:21AM (UTC+0700)

Submission ID: 1363375756

File name: ARTIKEL_PROCEEDING_1.pdf (1.32M)

Word count: 5534

Character count: 28883

PAPER • OPEN ACCESS

A Comparative of business process modelling techniques

To cite this article: I R H T Tangkawang and J Waworuntu ¹ 2016 *IOP Conf. Ser.: Mater. Sci. Eng.* **128** 012010

View the [article online](#) for updates and enhancements.

Related content

- [Technologies and problems of reengineering of the business processes of company](#)
Dmitriy Silka
- [Efficiency of innovative technology in construction industry](#)
H Stverkova and V Vaclavik
- [Redefining the business process of Department of Food Security and Agriculture in Government of Surabaya City](#)
H Cahyono and N A Wessiani

Recent citations

- [On leveraging the fruits of research efforts in the arena of business process modeling formalisms: a map-driven approach for decision making](#)
Afeef Awadid *et al*

A Comparative of business process modelling techniques

I R H T Tangkawarow* and J Waworuntu

Universitas Negeri Manado , North Sulawesi, Indonesia

*Corresponding author: irene_tangkawarow@yahoo.com

Abstract. In this era, there is a lot of business process modeling techniques. This article is the research about differences of business process modeling techniques. For each technique will explain about the definition and the structure. This paper presents a comparative analysis of some popular business process modelling techniques. The comparative framework is based on 2 criteria: notation and how it works when implemented in Somerleyton Animal Park. Each technique will end with the advantages and disadvantages. The final conclusion will give recommend of business process modeling techniques that easy to use and serve the basis for evaluating further modelling techniques.

1. Introduction

Nowadays, business competition causing companies to optimize existing business processes within the organization. Analysis the business process modeling is a tool to evaluate and make improvements over the business process there. Through the analysis of business they can decide which one is optimal or not optimal run and give attention to it.

Business process modeling is that activity aimed at the representation of all or some elements in order to produce a cohesive model of the behavior required to deliver a service and/or product to a customer or another part of the organization [2]. There are some techniques to model the business process. In practice it is not easy to determine which techniques are suitable and easily understood by stakeholders. Due to frequent misunderstanding between analyst system with a business owner or even between analyst system with the team (eg. Programmers). It required research on comparative of business process modeling techniques to overcome the above problems. This research is limited in four business process modeling techniques which often used the comparative analysis phase. The four business process modeling techniques are (1) Data Flow Diagram (DFD), (2) Business Process Modelling Notation (BPMN), (3) Activity Diagram, and (4) Integration Definition for Function Modelling (IDEF0).

The most interesting issues in business process modelling is the enormous availability of different techniques for the representation of organizational processes and their requirements [2]. Individual techniques can focus on different facets of process modelling. For example, while Activity Diagrams emphasis on the interaction between roles in the organization [8], Data Flow Diagrams (DFD) focus on the flow of data through a system [7]. This paper presents a comparative analysis each modeling techniques to explain the definition, notation and how it works implemented in the same process. Breeding process in the Somerleyton Animal Park is the scenario which used to show the difference each model.

As previous comparative analyses, Aldin L and de Cesare S [2] focus on comparison criteria to provide the reason overview. This paper presents the difference between four business process model



with comparison criteria, implementation using the same scenario, advantages and disadvantages each model.

2. Comparative Analysis

In the subsections that follow a breeding process in the Somerleyton animal park is used as a scenario to exemplify the different types of notation. The breeding process scenario refers to the process for animal breeding. The system admin checks into the system which animal is ready to breed and check if there is an animal in the park is available to breed for. When the animal and his partner is available, then do the breeding by animal keeper. But if not, then system admin has to contact another animal park, which having an animal as partner and arrange schedule when and where the breeding will be done.

2.1 Data Flow Diagram (DFD)

Data flow diagram used to describe how the system is processing data and information, in terms of input and output [8].

- The general principle in Data Flow Diagramming is that a system can be decomposed into subsystems, and subsystems can be decomposed into lower level subsystems, and so on.
- Each subsystem represents a process or activity in which data is processed. At the lowest level, processes can no longer be decomposed.
- Each 'process' (and from now on, by 'process' mean subsystem and activity) in a DFD has the characteristics of a system.
- Just as a system must have input and output (if it is not dead), so a process must have input and output.
- Data enters the system from the environment; data flows between processes within the system; and data are produced as output from the system

2.1.1 Notation

this paper will use DFD notation from Yourdan and De Marco [13], which explain below

Entity

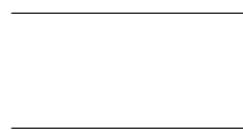

An entity is the source or destination of data. The source in a DFD represents these entities that are outside the context of the system. Entities either provide data to the system (referred to as a source) or receive data from it (referred to as a sink) [4][13].

Process



or

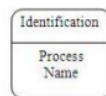

There are two notation for process in DFD from Yourdon & De Marco and Gene & Sarson. Processes can be symbolized as a circle or segmented rectangle that consist of an identifier like process number and process name [4].

Data Store

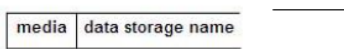

A data store is where a process stores data between processes for later retrieval by that same process or another one. The naming data store should be simple but meaningful. The data store is the place to store data in the system [13].

Data Flow



Data Flow is place to flow the information. Describe with straight lines that connected all the component of the system. Data flow showing with arrow and given name line or data flow[13]. This data flow stream between process, data store, and external entity and showing data flow can be input for the system or output system.

2.1.2. Structure

Context Diagram

Only represent single process, show the whole activities of the process and give the boundaries of the system. The one process connects to external entities and the data flow that connect it to the process [13].

Level 0 Diagram

Showing the overall process of the system, each part of functional requirement of the system represent by one mayor process. Can use one single data store as an aggregate to represent all data that is used in this level.

Level-n Diagram

A detailed processes of a level-0 diagram. Each process is represented by its own DFD. Data flows of a higher level break into component pieces. With the components shown on lower level and each lower level shows greater and greater detail.

2.1.3 Applied to Somerleyton Animal Park

Context Diagram



Figure 1. Context Diagram

The context diagram shown there are two employees. The first entity is employee as system administrator who works directly to Animal Park Information System. The second entity is employee as animal keeper who take care the animal.

DFD Level 0

In the DFD level 0 shows there are 3 process such as (1.0) breeding animal, (2.0) feeding the (3.0) animal and order food. Breeding the animal process is the process that we want to breakdown into DFD Level 1.

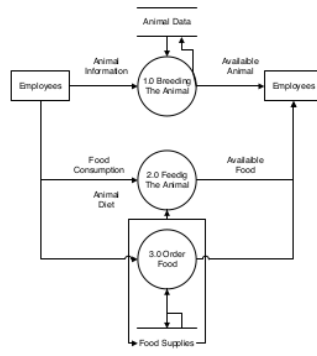

Figure 2. DFD Level 0

DFD Level 1- Breeding Animal

Breeding the animal process is breakdown, there are 4 sub process in breeding the animal show in DFD level 1 in pictures below:

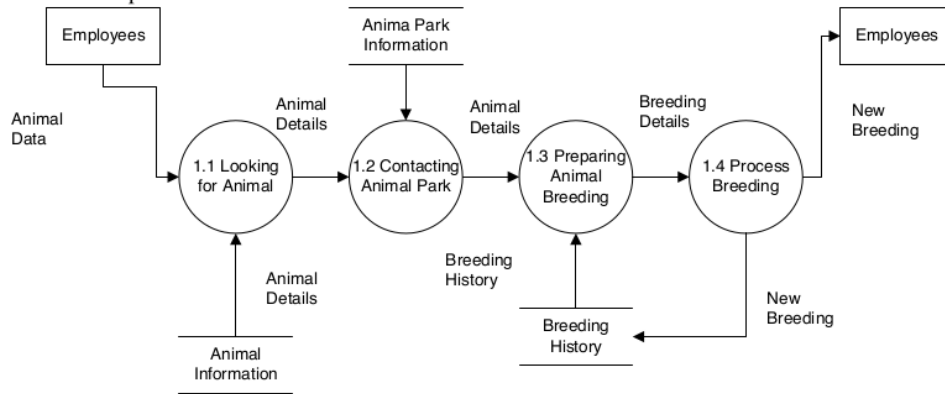

Figure 3. DFD Level 1

2.1.4 Advantages And Disadvantages

- Easy to understand for technical or non-technical persons because it uses simple symbols.
- Because it is very high level, it helps to define the boundaries of the system.
- The ability to represent the system in different levels. A global model in the first level can be worked out in more detail in the lower levels.
- Represent the information of data movements, this gives a clear view of what comes in the process and what not.
- Some symbols are being used in different kind of situations, this can be quite confusing.
- Because DFD is very high level, it isn't very useful when modeling complex processes.
- Modeling a large system will result in big models that are vague and probably will not cover the whole system.
- There is no possibility to model decisions in one model. A decision has to be modelled in more different models where each model stands for a decision-option. In a large, complex system this will result in hundreds of models with no real structure.
- Useless if without the pre-requisite details of the system.

2.2 Business Process Modeling Notation (BPMN) Version 1.1

The Business Process Modeling Notation (BPMN) is a graphical notation that depicts the steps in a business process [11]. BPMN shows the end to end flow of a business process. The notation has been specifically designed to coordinate the sequence of processes and the messages that flow between different process participants in a related set of activities [11] [12].

2.2.1 Notation

Events

An event is represented by a circle and is something that “happens” during the course of a business process [11]. These events affect the flow of the process and usually have a cause (trigger) or an impact (result). Events are circles with open centers to allow internal markers to differentiate different triggers or results. There are three types of Events, based on when they affect the flow: Start, Intermediate and

End. Events are also classified as Catching (as in, they might catch an incoming message to start the process) or Throwing (as in, they might throw a message at the end of the process)[12].



Figure 4. events [11]

Start event

Start Event indicates where a particular process will start. A start event is a circle that have to be drawn in thin line [11].

End event

Represents the result of a process; indicated by a single thick or bold border; and can only Throw, so is shown with a solid icon [11].

Intermediate event

Represents something that happens between the start and end events; is indicated by a tramline border; and can Throw or Catch (using solid or open icons as appropriate) [11] for example, a task could flow to an event that throws a message across to another pool and a subsequent event waits to catch the response before continuing.

4

Activity

An Activity is represented by a rounded-corner rectangle and is a generic term for work that company performs. An Activity can be atomic or nonatomic compound). The types of Activities are: Task and Sub-Process. The Sub-Process is distinguished by a small plus sign in the bottom center of the shape. [11]



Figure 5. Activity [11]

Task

A task represents a single unit of work that is not broke down to a further level of business process detail without diagramming the steps in a procedure (not the purpose of BPMN) [11]

Sub-process

Used to hide or reveal additional levels of business process detail - when collapsed a sub-process is indicated by a plus sign against the bottom line of the rectangle; when expanded the rounded rectangle expands to show all flow objects, connecting objects, and artifacts.[11]

Has its own self-contained start and end events, and sequence flows from the parent process must not cross the boundary.

Transaction

A form of sub-process in which all contained activities must be treated as a whole, i.e., they must all be completed to meet an objective, and if any one of them fails they must all be compensated (undone). Transactions are differentiated from expanded sub-processes by being surrounded by a tramline border [11].

4
Gateway

A Gateway is represented by a diamond shape and will determine forking and merging of paths depending on the conditions expressed [11].

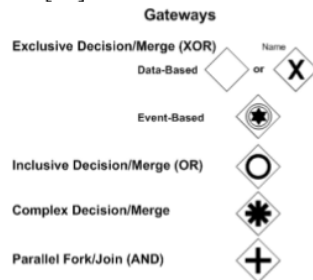

Figure 6. gateway symbol [11]

Object Connector

Flow objects are connected to each other using Connecting objects, which consist of three types (Sequences, Messages, and Associations) [11]:

4
Sequence Flow

A Sequence Flow is represented by a solid line with a solid arrowhead and is used to show the order (the sequence) that activities will be performed in a Process. The sequence flow may also have a symbol at its start, a small diamond indicates one of a number of conditional flows from an activity while a diagonal slash indicates the default flow from a decision or activity with conditional flows.



Message Flow

A Message Flow is represented with a dashed line, an open circle at the start, and an open arrowhead at the end. It tells us what messages flow across organizational boundaries (i.e., between pool). A message flow can never be used to connect activities or events within the same pool. Message flow used to show the flow of messages between two separate Process Participants (business entities or business rules) that send and receive them. In BPMN, two separate Pools in the Diagram will represent the two Participants.



Association

An Association is represented by a dotted line. It is used to associate an Artifact or text to a Flow Object, and can indicate some directionality using an open arrowhead (toward the artifact to represent a result, from the artifact to represent an input, and both to indicate it is read and updated). No directionality would be used when the Artifact or text is associated with a sequence or message flow (as that flow already shows the direction).



Swimlane

2
 Many processes modeling methodologies utilize the concept of swimlanes as a mechanism to organize activities into separate visual categories in order to illustrate different functional capabilities or responsibilities. BPMN supports swimlanes with two main constructs. The two types of BPD swimlane objects are:

Pool

A Pool represents a Participant in a Process. It is also acts as a graphical container for partitioning a set of activities from other Pools, usually in the context of B2B situations.



Figure 7. pool

Lane

Lane is a sub-partition within a Pool and will extend the entire length of the Pool, either vertically or horizontally. Lanes are used to organize and categorize activities.



Figure 8. lane

Artifacts

BPMN was designed to allow modelers and modeling tools some flexibility in extending the basic notation and in providing the ability to additional context appropriate to a specific modeling situation, such as for a vertical market (e.g., insurance or banking). Any number of Artifacts can be added to a diagram as appropriate for the context of the business processes being modeled. The current version of the BPMN specification pre-defines only three types of BPD Artifacts, which are:

Data Object

Data Objects are a mechanism to show how data is required or produced by activities. They are connected to activities through Associations.



Figure 9. data object

Group

A Group is represented by a rounded corner rectangle drawn with a dashed line. The grouping can be used for documentation or analysis purposes, but does not affect the Sequence Flow.



Figure 10. group

Annotation

Annotations are a mechanism for a modeler to provide additional text information for the reader of a BPMN Diagram.

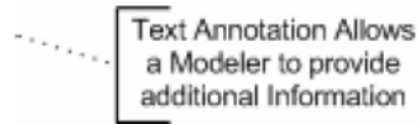
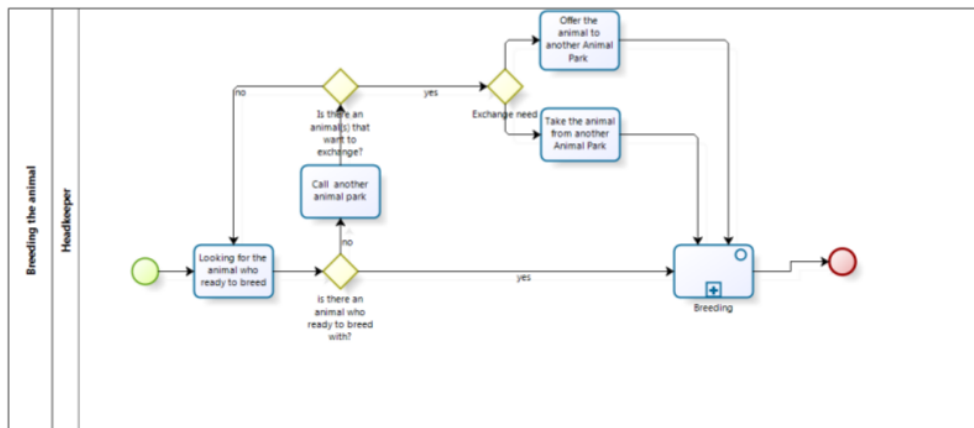

Figure 11. annotation

2.2.2 Applied to Somerleyton Animal Park

In the figure below show the pool indicated as process breeding the animal and the lane as headkeeper or animal keeper. There are 5 tasks inside the lane of animal keeper.



powered by
BizAgg
Process Modeler

Figure 12. BPMN breeding animal

2.2.3 Advantages and Disadvantages

- Easy to understand the flow and the process
- It bridges the gap between business and technical systems personnel.
- It can be scaled for any kind of project ranging from smaller activities to complex activities.
- More likely to find the skills without having to pay for proprietary language specialists.
- It offers a process flow modeling technique that is more conducive to the way business analyst model
- Completeness notation depicting various processes.
- There are ambiguity and confusion in sharing BPMN models, for example: It is possible to model the same process with different notation variations
- There is no standardized file format for exchange BPMN models between different tools

2.3 Activity Diagrams

Activity diagrams are used to map workflows. It is a graphical representation of the steps, actions and decisions that are made in a certain process [10]. Activity diagrams are part of the modeling language UML (Unified Modeling Language), that is a set of different graphic notation techniques to create visual models.

2.3.1 Notation

Initial Activity

The initial activity is a big black circle that shows the starting point of the flow [10].



Activity

Represents an activity as a rounded rectangle [10].

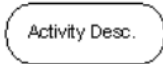

Decisions

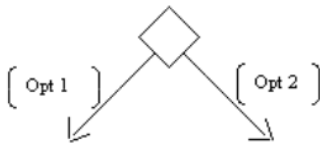

When a decision has to be made a diamond with different lines is stated [10]. The options of the decision are written next to each line. A decisive element can have as many options that are needed, but has to have at least two.

Signal



When an activity, sends or receives a message, that activity is called a signal. There are two different types of signals. An input signal and an output signal. An input signal is a message that is received by an activity and a output signal is a message that is sent by an activity [10].

Concurrent Activities

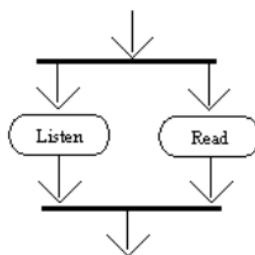

When activities take place at the same time they are called concurrent activities. For instance, it's possible to listen and read at the same time. These activities, then parallel with each other. The horizontal thick black lines say that the process waits for both parallel activities to be completed before moving to the next activity.[10]

Final activity

The end of the activity diagram is shown by a black spot within a white circle. It means that all activities in the diagram are ended. [10]



2.3.2 Applied to Somerleyton Animal Park

The figure below shows the activity diagram for breeding the animal process. The activity diagram consists of three initial activity: Looking for animal who ready to breed, breeding, and contact the animal park.

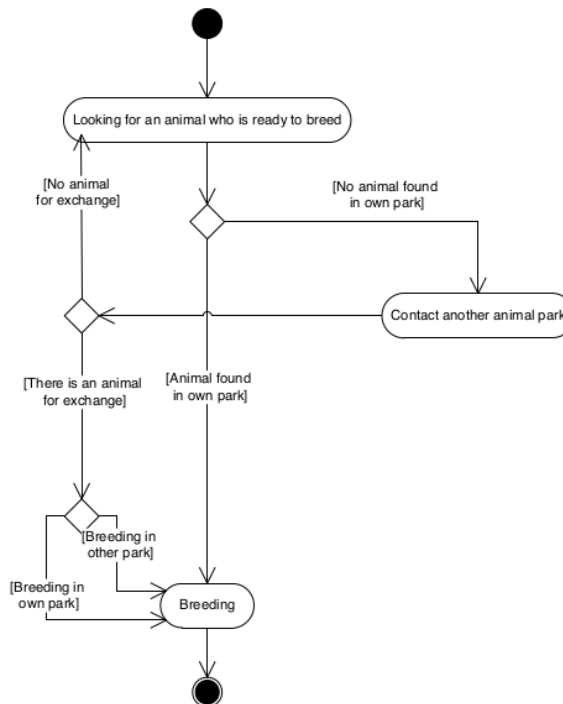

Figure 13. activity diagram breeding animal

2.3.3 Advantages and Disadvantages

- Activity diagrams are high level. This can be a big advantage when discussing business processes with the customer in an early stage of the development.
- Activity diagrams are easy to understand, also for someone with no technical background if it comes to modeling business processes.
- Activity diagrams have a flow so that it's clear which activities are performed by the outcome of the different decisions in the diagram.
- In activity diagrams it is possible to determine that activities run parallel with each other.
- There are no restrictions on what can or can't be an activity.
- Because activity diagrams are high level, it's difficult to describe complex processes.
- With activity diagrams it's not possible to describe which different objects or actors are performing which actions.
- There are no distinctions between activities, this can be confusing.

2.4. Integration Definition for Function Modelling (IDEF0)

IDEF0 is a modeling technique which can be used to display the actions, decisions and activities of an organization of system [1]. The model helps the analyst by analyzing the system and are commonly used to communicate the analysis to the customer. The activities can be described by their inputs, outputs, controls, and mechanisms.

IDEF0 can be used for new to develop systems or for analyzing existing systems. For new systems IDEF0 can be used to determine the requirements and functions for the system. In existing systems IDEF0 can be used to analyze the functions of the system and their mechanisms (Who is executing the function).

2.4.1 Notation

The IDEF0 notation consists of boxes that represents activities in the system and arrows that describes the relations between the activities [1].

- Activities (box)
 - Activities can be worked out in more detail (decomposition)
- Data and Object, that connects the activities together (arrow)
 - Inputs: transformed by Activity into outputs
 - Controls: dictate & constrain under what conditions transformations occur
 - Outputs: created as a result of activity transformations
 - Mechanisms: describe how the activity is to be carried out (resource, process, etc.)

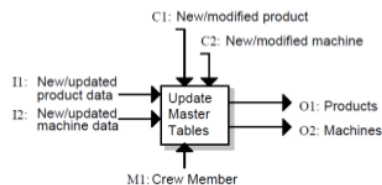

Figure 14. IDEF0 notation [1]

When we connect activities together, we have to keep in mind that only the following is allowed:

- To go from output to input;
- To go from output to control;
- To go from the output to mechanism;

2.4.2 Applied to Somerleyton Animal Park

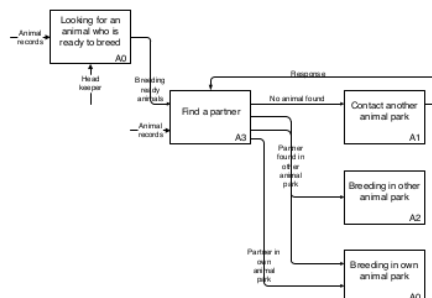

Figure 15. idefo breeding animal

2.4.3 Advantages and Disadvantages

- The distinction between input, controls, output and mechanisms will help the reader understanding the activity better.
- You can start with a high level model and work it out over time in more details
- Provides strict rules for modeling what will result in a clear and high quality model.
- Difficult to model, read and understand
- Not a very commonly used modeling technique

6. Result and Discussion

In this part we are going to compare the different techniques with each other. As an example, we use the process 'animal breeding' of the Somerlayton Animal Park. The models for this process are listed previously, but are repeated here to make things a little bit easier.

Model 1, DFD

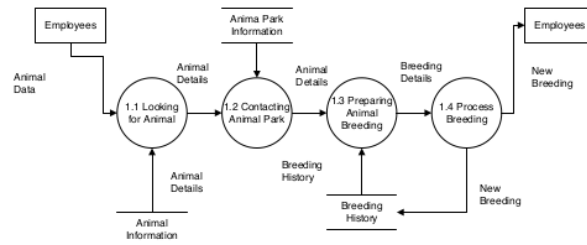

Figure 16 DFD Breeding The Animal Process

One reason for these differences are of course the developers. Not every developer thinks completely the same and can't empathize himself in the situation as good as another. The other reason is the features of each modeling technique. For instance, in

Model 1 the DFD model for the process breeding an animal is listed. If you compare this model with the others you will see that in every other model some decisions are present. With DFD listing a decision in one model isn't possible, so in

Model 1 some important information is missing. In this case a user will not know that the breeding activity can be in their own zoo but also in another zoo.

Model 2, BPMN

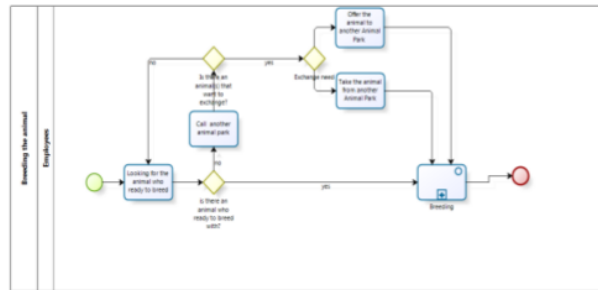

Figure 17 BPMN breeding the animal process

Everything about the process 'breeding an animal' is present in Model2. Decisions are clear and due the simplicity in symbols, the flow is easy to follow. The possibility of making decisions is also possible in activity diagrams and IDEF0 so that isn't a big plus compared to the other modeling techniques. What we do think that is a big plus are the symbols. In BPMN there are a lot of different symbols, but there are grouped in types. This keeps things simple, but also gives the analyst the choice in which detail he wants to model the process. Also the use of colors is handy, in One reason for these differences are of course the developers. Not every developer thinks completely the same and can't empathize himself in the situation as good as another. The other reason is the features of each modeling technique. For instance, in

Model 1 the DFD model for the process breeding an animal is listed. If you compare this model with the others you will see that in every other model some decisions are present. With DFD listing a decision in one model isn't possible, so in

Model 1 some important information is missing. In this case a user will not know that the breeding activity can be in their own zoo but also in another zoo.

Model 2 the green round means the start of the process and the red one means the process stops. This sounds very logical, but the other techniques don't use colored symbols.

The negative side of BPMN is that despite it's easy to understand, we find it quite hard to model. In our experience modeling with BPMN takes a lot of time and arouses many discussing. Also, due all the possibilities, it's possible that different looking models are describing exactly the same process. These equivalent models can cause some confusion, especially when the analysts aren't very experienced.

Model 3, Activity Diagram

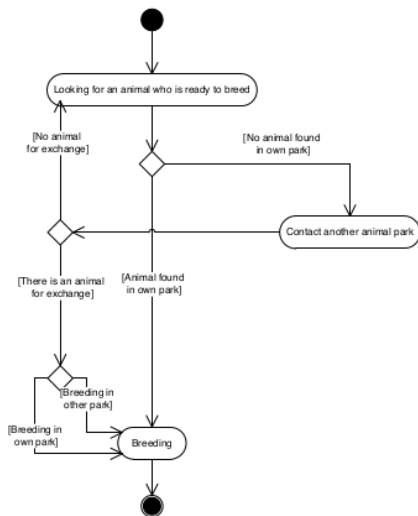

Figure 18. activity diagram breeding the animal process

Comparing Model3 with other models we can say that activity diagrams have the biggest similarity with BPMN models. It has the same rounded rectangles for the actions and also uses the diamonds for decision making. We see activity diagrams as a simple version of BPMN. The features of activity diagrams are also included in BPMN and are done almost the same way.

When comparing the different modeling techniques were wondering, does every model tell the same story? Basically, that answer is yes. But when these models are given, that are each made by using a different technique and by different developers the outcome will not be very equivalent.

Model 4, IDEF0

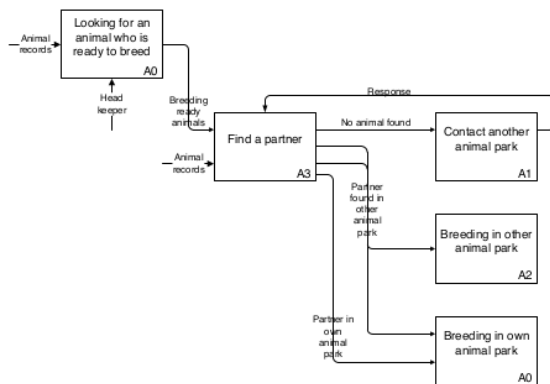

Figure 19. IDEF0 breeding the animal process

Model 4 is the toughest model to make and to understand, but provides the most information. The model of BPMN and the Activity Diagram says nothing about the input, output, mechanisms and controls. And that is what makes IDEF0 really interesting. The mechanisms and controls are sometimes hard to define,

but the possibility to make clear what the input and the output of an activity area, is really a big plus of IDEF0. The feature of defining these so called ICOM's helps the developer to understand the process even better. Now he knows who and what is involved in each activity and what the result of each activity is. This advantage of IDEF0 can also be seen as a disadvantage because these kind of technical details is not interesting for example to the customer.

7. Conclusion

The conclusion is that no modeling technique is beforehand better than another. It all depends on the situation. DFD give the overview about the flow of data in the system about the source and destination of the data. DFD is not powerful to show the whole process that happened in the system. DFD does not have symbols to display branching process in the system. BPMN has a clear symbol to overview the whole process so people can easily understand the business process. Business people use BPMN to express and understanding process and technical based people use it to translate process into the system. Activity Diagram analyzes the case with describing what actions need to do and when that action should occurred. Activity diagram can describe complicated sequence of the system and modeling the parallel process in the system. IDEF0 modeling activity sequences whenever needed. Sometimes only the domain expert can understand the sequence and the activities represented by IDEF0.

8. References

- [1] Ross D. T, SofTech. Inc. (1993, December 21). *IDEF Integrated DEFinition Method*. Retrieved 06 23, 2015, from IDEFØ Function Model Method: <http://www.idef.com/pdf/idef0.pdf>
- [2] Aldin L. , de Cesare S. (2009). A Comparative Analysis of Business Process Modelling Techniques. *U.K. Academy for Information Systems (UKAIS 2009), 14th Annual* (pp. 1-17). Oxford: UKAIS 2009.
- [3] Alzubidi N.H., Recker J., Bernhard E. (2011). *A Study of the Use of Business Process Modelling at SunCorp*. Brisbane: Business Process Management Research Group QUT.
- [4] Braghetto K.R, Ferreira J.E, Vincent J. (2009). *Comparison of Modeling Approaches to Business*. France: Rapport de recherche n° 7065.
- [5] DeMarco, J. (1979). *Structured Analysis and System Specification*. Englewood: Prentice-Hall.
- [6] Fortis, A. (2006). Business Process Modelling Notation- An Overview. *Annals. Computer Science Series. 4th Tome 1st Fasc*, 41-49.
- [7] H Shen, B Wall, M Zaremba, Y Chen, J Brownie. (2004). Integration of business modelling methods for enterprise information system analysis and user requirement gathering. *Computers in Industry volume 54, 54*(Computers in Industry), 307-323.
- [8] Ould, M. (1995). *Business processes: modelling and analysis for re-engineering and improvement*. Wiley.

- [9] Pressman, R. (2010). *Software Engineering: A Practitioner's Approach, Seventh Edition*. Mc Graw Hill Higher Education.
- [10] Rumbaugh J, Jacobson I, Booch G. (1999). *The Unified Modeling Language Reference Manual*. Massachusetts: Addison-Wesley.
- [11] White, S. (2006, October 16). *Introduction to BPMN*. Retrieved January 10, 2011, from IBM Software Group: http://www.bpmn.org/Documents/OMG_BPMN_Tutorial.pdf
- [12] White, S. A. (2006). *Introducion to BPMN*. IBM Corporation.
- [13] Yourdan E, L. L. (1979). *Structured Design: Fundamentals of a Discipline of Computer Program and System Design*. Englewood: Prentice-Hall.

A Comparative of business process modelling techniques

ORIGINALITY REPORT

21%

SIMILARITY INDEX

18%

INTERNET SOURCES

14%

PUBLICATIONS

%

STUDENT PAPERS

PRIMARY SOURCES

- 1 Sifa, Agus, Badruzzaman, and Dedi Suwandi. "Ply Thickness Fiber Glass on Windmill Drive Salt Water Pump", IOP Conference Series Materials Science and Engineering, 2016. 7%
Publication
- 2 www.visual-paradigm.com 5%
Internet Source
- 3 usep-ic.forumsmotions.com 3%
Internet Source
- 4 enblog.enterprise-concept.com 3%
Internet Source
- 5 Aldin, L and de Cesare, S. "A comparative analysis of business process modelling techniques", UKAIS, 2010. 3%
Publication

Exclude quotes Off

Exclude bibliography On

Exclude matches < 3%